

# GE3

## 3-WAY HIGH PRESSURE BALL VALVES

### CARBON STEEL

- Type: ball valve 3 way
- Sizes: from DN4 up to DN25
- Ends: BSP-NPT-SAE-DIN
- O-Rings: NBR, FKM, EPDM, MVQ
- Pressure: up to PN500
- Temp range: -20°C to +100°C

### STAINLESS STEEL

- Type: ball valve 3 way
- Sizes: from DN4 up to DN25
- Ends: BSP-NPT-SAE-DIN
- O-Rings: NBR, FKM, EPDM, MVQ
- Pressure: up to PN500
- Temp range: -30°C to +100°C

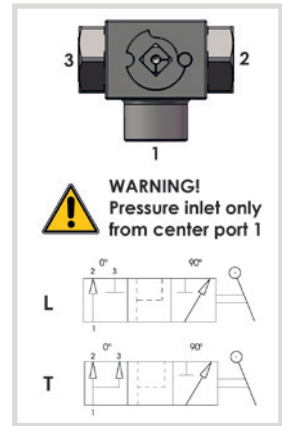
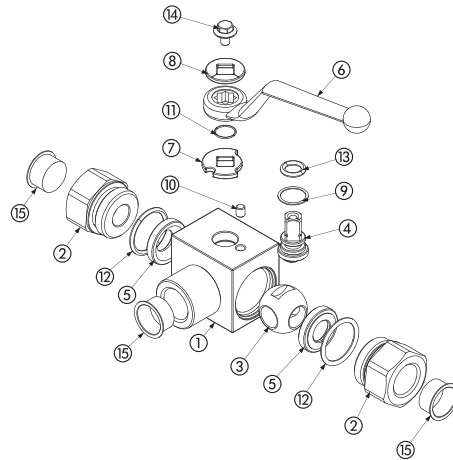

**CARBON STEEL**

POS	DESCRIPTION	MATERIAL	Q.TY
1	Body	1,0737	1
2	Adapter	1,0737	2
3	Ball	1,0737	1
4	Stem	1,0737	1
5	Ball seat	POM	2
6	Handle	ZINC	1
7	Washer	1,0116	1
8	Washer	1,0116	1
9	Stem ring	POM	1
10	Spine	1,0737	1
11	Seeger	1,4301	1
12	Adapter o-ring	NBR	2
13	Stem o-ring	NBR	1
14	Screw	Din 6921 8.8	1
15	Caps	PVC	3

**CARBON STEEL**

		GE3		G½		DN13		1	1	1	1	A	B
TYPE AND WAY OF VALVE	GAS DIN/ ISO 228 BSP	NPT ANSI/ ASME B1.20.1	SAE J1926-1	DIN 2353 HEAVY SERIES	DIN 2353 LIGHT SERIES	NOMINAL DIMENSION	BODY MATERIAL	ADAPTER MATERIAL	STEM MATERIAL	BALL MATERIAL	BALL SEAT MATERIAL	ADAPTER AND STEM SEAL MATERIAL	
GE3 3-way	G ½	N ½	SAE4	8S	6L	DN4	1 1,0737	1 1,0737	1 1,0737	1 1,0737	A POM	B NBR	
	G ¼	N ¼	SAE6	10S	8L	DN6			4 1,4404*	4 1,4404*	D PEEK*	E FKM*	
	G ¾	N ¾	SAE8	12S	10L	DN10					G PA612*	F EPDM*	
	G ½	N ½	SAE12	14S	12L	DN13					K GEMPTFE*	L MVQ*	
	G ¾	N ¾	SAE16	16S	15L	DN20					C PTFE*		
	G 1	N 1	SAE20R	20S	18L	DN25							
	G 1 ¼ R	N 1 ¼ R	SAE24R	25S	22L								
	G 1 ½ R	N 1 ½ R		30S	28L								
				38S	35L								
					42L								

**STAINLESS STEEL**

POS	DESCRIPTION	MATERIAL	Q.TY
1	Body	1,4404	1
2	Adapter	1,4404	2
3	Ball	1,4404	1
4	Stem	1,4404	1
5	Ball seat	POM	2
6	Handle	ZINC	1
7	Washer	1,4301	1
8	Washer	1,4301	1
9	Stem ring	POM	1
10	Spine	1,4301	1
11	Seeger	1,4301	1
12	Adapter o-ring	NBR	2
13	Stem o-ring	NBR	1
14	Screw	Din 6921 A2	1
15	Caps	PVC	3

**STAINLESS STEEL**

		GE3		G½		DN13		4	4	4	4	A	B
TYPE AND WAY OF VALVE	GAS DIN/ ISO 228 BSP	NPT ANSI/ ASME B1.20.1	SAE J1926-1	DIN 2353 HEAVY SERIES	DIN 2353 LIGHT SERIES	NOMINAL DIMENSION	BODY MATERIAL	ADAPTER MATERIAL	STEM MATERIAL	BALL MATERIAL	BALL SEAT MATERIAL	ADAPTER AND STEM SEAL MATERIAL	
GE3 3-way	G ½	N ½	SAE4	8S	6L	DN4	4 1,4404	4 1,4404	4 1,4404	4 1,4404	A POM	B NBR	
	G ¼	N ¼	SAE6	10S	8L	DN6					D PEEK*	E FKM*	
	G ¾	N ¾	SAE8	12S	10L	DN10					G PA612*	F EPDM*	
	G ½	N ½	SAE12	14S	12L	DN13					K GEMPTFE*	L MVQ*	
	G ¾	N ¾	SAE16	16S	15L	DN20					C PTFE*		
	G 1	N 1	SAE20R	20S	18L	DN25							
	G 1 ¼ R	N 1 ¼ R	SAE24R	25S	22L								
	G 1 ½ R	N 1 ½ R		30S	28L								
				38S	35L								
					42L								

\*On request:

- Reduced bore
- Special threads

- Pressure class up to PN40 MPa
- Pneumatic and electrical actuator

- Security block
- Locking device

For further special requests please consult our technical/commercial service

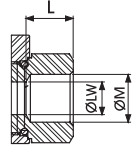
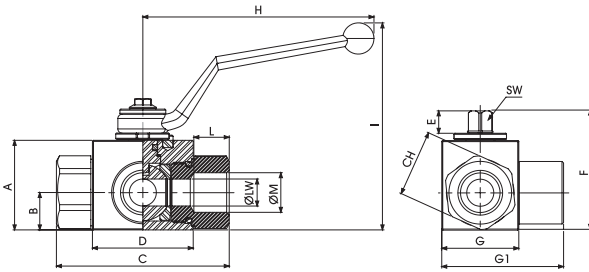

## GE3 DIN/ISO 228 BSP

Standard

TYPE	PN	DN	A	B	C	D	E	F	G	G1	H	I	L	ØM	CH	SW	ØLW	KG	CARBON STEEL	STAINLESS STEEL
																			ITEM CODE	ITEM CODE
GE3 G 1/8	50 MPa	4	35	14,5	71	42,4	11	49	30	48,5	110	91,5	11	G 1/8	24	9	4	0,558	GE3GGT04011A000	GE3GGT04044A000
GE3 G 1/4	50 MPa	6	35	14,5	71	42,4	11	49	30	48,5	110	91,5	15,5	G 1/4	24	9	6	0,536	GE3GGT14011A000	GE3GGT14044A000
GE3 G 3/8	50 MPa	10	40	17,4	73	44,4	11	54,25	35	54,5	110	96,5	15,5	G 3/8	30	9	10	0,695	GE3GGT24011A000	GE3GGT24044A000
GE3 G 1/2	50 MPa	13	43	18	83	48,4	11	57	37	58,5	110	99,5	17	G 1/2	32	9	13	0,825	GE3GGT33011A000	GE3GGT33044A000
GE3 G 3/4	42/40 MPa	20	57	23,4	95	62,5	14	73,5	49	75	180	106,5	21	G 3/4	41	14	20	1,583	GE3GGT44011A000	GE3GGT43044A000
GE3 G 1	42/35 MPa	25	65	29,5	112	66,5	14	83,5	55	89	180	116,5	24	G 1	50	14	25	2,421	GE3GGT53011A000	GE3GGT53044A000
GE3 G 1 1/4 R	35 MPa	25	65	29,5	120	66,5	14	83,5	55	89	180	116,5	24	G 1 1/4	55	14	25	2,601	GE3GGR63011A000	GE3GGR63044A000
GE3 G 1 1/2 R	35 MPa	25	65	29,5	124	66,5	14	83,5	55	89	180	116,5	24	G 1 1/2	60	14	25	2,756	GE3GGR73011A000	GE3GGR73044A000

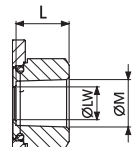

## GE3 ANSI/ASME B1.20.1 NPT

Standard

TYPE	PN	DN	A	B	C	D	E	F	G	G1	H	I	L	ØM	CH	SW	ØLW	KG	CARBON STEEL	STAINLESS STEEL
																			ITEM CODE	ITEM CODE
GE3 N 1/8	50 MPa	4	35	14,5	71	42,4	11	49	30	48,5	110	91,5	11	N 1/8	24	9	4	0,558	GE3NNT04011A000	GE3NNT04044A000
GE3 N 1/4	50 MPa	6	35	14,5	71	42,4	11	49	30	48,5	110	91,5	17	N 1/4	24	9	6	0,536	GE3NNT14011A000	GE3NNT14044A000
GE3 N 3/8	50 MPa	10	40	17,4	73	44,4	11	54,25	35	54,5	110	96,5	17	N 3/8	30	9	10	0,695	GE3NNT24011A000	GE3NNT24044A000
GE3 N 1/2	50 MPa	13	43	18	83	48,4	11	57	37	58,5	110	99,5	21	N 1/2	32	9	13	0,825	GE3NNT33011A000	GE3NNT33044A000
GE3 N 3/4	42/40 MPa	20	57	23,4	95	62,5	14	73,5	49	75	180	106,5	21	N 3/4	41	14	20	1,583	GE3NNT44011A000	GE3NNT43044A000
GE3 N 1	42/35 MPa	25	65	29,5	112	66,5	14	83,5	55	89	180	116,5	24	N 1	50	14	25	2,421	GE3NNT53011A000	GE3NNT53044A000
GE3 N 1 1/4 R	35 MPa	25	65	29,5	120	66,5	14	83,5	55	89	180	116,5	24	N 1 1/4	55	14	25	2,601	GE3NNT63011A000	GE3NNT63044A000
GE3 N 1 1/2 R	35 MPa	25	65	29,5	124	66,5	14	83,5	55	89	180	116,5	24	N 1 1/2	60	14	25	2,756	GE3NNT73011A000	GE3NNT73044A000

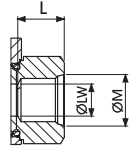

## GE3 SAE J1926-1

Standard

CARBON STEEL

TYPE	PN	DN	A	B	C	D	E	F	G	G1	H	I	L	ØM	CH	SW	ØLW	KG	ITEM CODE
GE3 SAE4	50 MPa	6	35	14,5	71	42,4	11	49	30	48,5	110	91,5	15,5	$7/16$ UNF	24	9	6	0,536	GE3EEE04011AF10
GE3 SAE6	50 MPa	10	40	17,5	73	44,4	11	54,25	35	54,5	110	96,5	16	$9/16$ UNF	30	9	10	0,695	GE3EEE14011AF10
GE3 SAE8	50 MPa	13	43	18	83	48,4	11	57	37	58,5	110	99,5	17,5	$3/4$ UNF	32	9	13	0,825	GE3EEE23011AF10
GE3 SAE12	42/40 MPa	20	57	23,4	95	62,5	14	73,5	49	75	180	106,5	23	$1 1/16$ UNF	41	14	20	1,583	GE3EEE34011AF10
GE3 SAE16	42/35 MPa	25	65	29,4	112	66,5	14	83,5	55	89	180	116,5	23	$1 5/16$ UNF	50	14	25	2,421	GE3EEE43011AF10
GE3 SAE20R	35 MPa	25	65	29,4	120	66,5	14	83,5	55	89	180	116,5	23	$1 5/8$ UNF	55	14	25	2,601	GE3EEE53011AF10
GE3 SAE24R	35 MPa	25	65	29,4	124	66,5	14	83,5	55	89	180	116,5	23	$1 7/8$ UNF	60	14	25	2,756	GE3EEE63011AF10

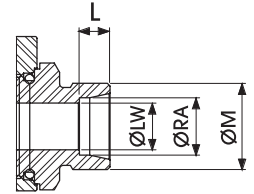
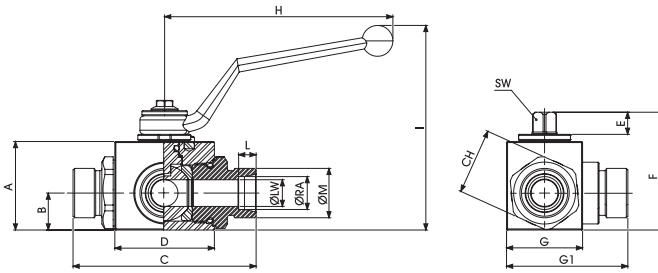

## GE3 DIN 2353 HEAVY SERIES

Standard

TYPE	PN	DN	A	B	C	D	E	F	G	G1	H	I	L	ØM	CH	SW	ØLW	ØRA	KG	CARBON STEEL	STAINLESS STEEL
																				ITEM CODE	ITEM CODE
GE3 8S	50 MPa	6	35	14,5	76	42,4	11	49	30	48,5	110	91,5	7	M16x1,5	24	9	4	8	0,53	GE3DDS04011A000	GE3DDS04044A000
GE3 10S	50 MPa	6	35	14,5	76	42,4	11	49	30	48,5	110	91,5	7,5	M18x1,5	24	9	6	10	0,532	GE3DDS14011A000	GE3DDS14044A000
GE3 12S	50 MPa	8	35	14,5	76	42,4	11	49	30	48,5	110	91,5	7,5	M20x1,5	24	9	8	12	0,535	GE3DRS4011A000	GE3DRS4044A000
GE3 12S	50 MPa	10	40	17,4	76	44,4	11	54,25	35	54,5	110	96,5	7,5	M20x1,5	30	9	10	12	0,633	GE3DDS24011A000	GE3DDS24044A000
GE3 14S	50 MPa	10	40	17,4	82,5	44,4	11	54,25	35	54,5	110	96,5	8	M22x1,5	30	9	10	14	0,665	GE3DDS34011A000	GE3DDS34044A000
GE3 16S	50 MPa	13	43	18	89	48,4	11	57	37	59	110	99,5	8,5	M24x1,5	32	9	13	16	0,722	GE3DDS43011A000	GE3DDS43044A000
GE3 20S	50 MPa	13	43	18	93	48,4	11	57	37	59	110	99,5	10,5	M30x2	32	9	13	20	0,861	GE3DDS53011A000	GE3DDS53044A000
GE3 25S	35/40 MPa	20	57	23,4	111	62,5	14	73,5	49	75	180	106,5	12	M36x2	41	14	20	25	1,639	GE3DDS64011A000	GE3DDS63044A000
GE3 30S	35 MPa	25	65	29,5	121	66,5	14	83,5	55	89	180	116,5	13	M42x2	50	14	25	30	2,361	GE3DDS73011A000	GE3DDS73044A000
GE3 38S	35 MPa	25	65	29,5	131	66,5	14	83,5	55	89	180	116,5	16	M52x2	55	14	25	38	2,655	GE3DDS83011A000	GE3DDS83044A000

## GE3 DIN 2353 LIGHT SERIES

Standard

TYPE	PN	DN	A	B	C	D	E	F	G	G1	H	I	L	ØM	CH	SW	ØLW	ØRA	KG	CARBON STEEL	STAINLESS STEEL
																				ITEM CODE	ITEM CODE
GE3 6L	50 MPa	6	35	14,5	76	42,4	11	49	30	48,5	110	91,5	7	M12x1,5	24	9	6	6	0,53	GE3DDL04011A000	GE3DDL04044A000
GE3 8L	50 MPa	6	35	14,5	76	42,4	11	49	30	48,5	110	91,5	7	M14x1,5	24	9	6	8	0,532	GE3DDL14011A000	GE3DDL14044A000
GE3 10L	50 MPa	6	35	14,5	76	42,4	11	49	30	48,5	110	91,5	7	M16x1,5	24	9	6	10	0,535	GE3DDRL4011A000	GE3DDRL4044A000
GE3 10L	50 MPa	10	40	17,4	76,5	44,4	11	54,25	35	54,5	110	96,5	7	M16x1,5	30	9	10	10	0,633	GE3DDL24011A000	GE3DDL24044A000
GE3 12L	50 MPa	10	40	17,4	79,5	44,4	11	54,25	35	54,5	110	96,5	7	M18x1,5	30	9	10	12	0,665	GE3DDL34011A000	GE3DDL34044A000
GE3 15L	50 MPa	13	43	18	87	48,4	11	57	37	59	110	99,5	7	M22x1,5	32	9	13	15	0,722	GE3DDL43011A000	GE3DDL43044A000
GE3 18L	50 MPa	13	43	18	87	48,4	11	57	37	59	110	99,5	7,5	M26x1,5	32	9	13	18	0,861	GE3DDL53011A000	GE3DDL53044A000
GE3 22L	35/40 MPa	20	57	23,4	110	62,5	14	73,5	49	75	180	106,5	7,5	M30x2	41	14	20	22	1,639	GE3DDL64011A000	GE3DDL63044A000
GE3 28L	35 MPa	25	65	29,5	117	66,5	14	83,5	55	89	180	116,5	7,5	M36x2	50	14	25	28	2,361	GE3DDL73011A000	GE3DDL73044A000
GE3 35L	35 MPa	25	65	29,5	119	66,5	14	83,5	55	89	180	116,5	10,5	M45x2	50	14	25	35	2,361	GE3DDL83011A000	GE3DDL83044A000
GE3 42L	35 MPa	25	65	29,5	119	66,5	14	83,5	55	89	180	116,5	11	M52x2	55	14	25	42	2,456	GE3DDL93011A000	GE3DDL93044A000

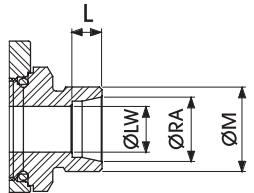

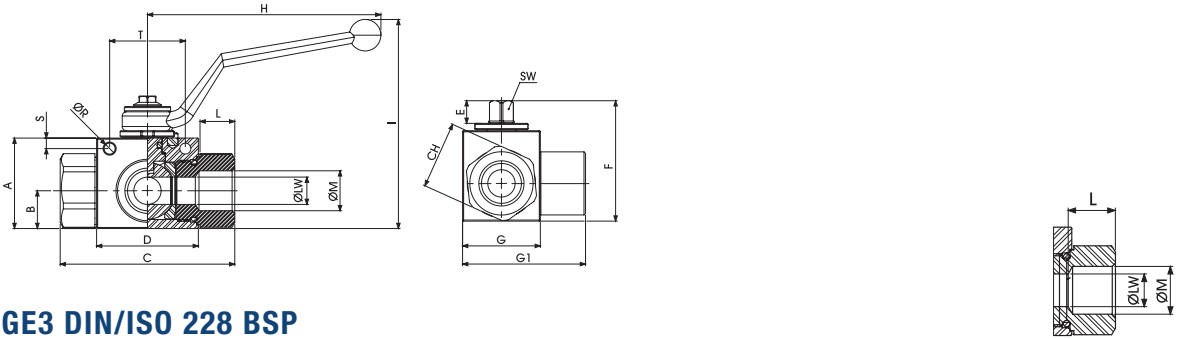

## GE3 DIN/ISO 228 BSP

Fixing holes

TYPE	PN	DN	A	B	C	D	E	F	G	G1	H	I	L	ØM	CH	ØR	S	T	SW	ØLW	KG	CARBON STEEL	STAINLESS STEEL
																						ITEM CODE	ITEM CODE
GE3 G 1/8	50 MPa	4	35	14,5	71	42,4	11	49	30	48,5	110	91,5	11	G 1/8	24	5,25	4,5	34	9	4	0,558	GE3GGT04011AF10	GE3GGT04044AF10
GE3 G 1/4	50 MPa	6	35	14,5	71	42,4	11	49	30	48,5	110	91,5	15,5	G 1/4	24	5,25	4,5	34	9	6	0,536	GE3GGT14011AF10	GE3GGT14044AF10
GE3 G 3/8	50 MPa	10	40	17,4	73	44,4	11	54,25	35	54,5	110	96,5	15,5	G 3/8	30	5,25	4,5	34	9	10	0,695	GE3GGT24011AF10	GE3GGT24044AF10
GE3 G 1/2	50 MPa	13	43	18	83	48,4	11	57	37	58,5	110	99,5	17	G 1/2	32	5,25	5	36	9	13	0,825	GE3GGT33011AF10	GE3GGT33044AF10
GE3 G 3/4	42/40 MPa	20	57	23,4	95	62,5	14	73,5	49	75	180	106,5	21	G 3/4	41	6,25	6	50	14	20	1,583	GE3GGT44011AF10	GE3GGT43044AF10
GE3 G 1	42/35 MPa	25	65	29,5	112	66,5	14	83,5	55	89	180	116,5	24	G 1	50	6,25	6	50	14	25	2,421	GE3GGT53011AF10	GE3GGT53044AF10
GE3 G 1 1/4 R	35 MPa	25	65	29,5	120	66,5	14	83,5	55	89	180	116,5	24	G 1 1/4	55	6,25	6	50	14	25	2,601	GE3GGR63011AF10	GE3GGR63044AF10
GE3 G 1 1/2 R	35 MPa	25	65	29,5	124	66,5	14	83,5	55	89	180	116,5	24	G 1 1/2	60	6,25	6	50	14	25	2,756	GE3GGR73011AF10	GE3GGR73044AF10

## GE3 ANSI/ASME B1.20.1 NPT

Fixing holes

TYPE	PN	DN	A	B	C	D	E	F	G	G1	H	I	L	ØM	CH	ØR	S	T	SW	ØLW	KG	CARBON STEEL	STAINLESS STEEL
																						ITEM CODE	ITEM CODE
GE3 N 1/8	50 MPa	4	35	14,5	71	42,4	11	49	30	48,5	110	91,5	11	N 1/8	24	5,25	4,5	34	9	4	0,558	GE3NNT04011AF10	GE3NNT04044AF10
GE3 N 1/4	50 MPa	6	35	14,5	71	42,4	11	49	30	48,5	110	91,5	15,5	N 1/4	24	5,25	4,5	34	9	6	0,536	GE3NNT14011AF10	GE3NNT14044AF10
GE3 N 3/8	50 MPa	10	40	17,4	73	44,4	11	54,25	35	54,5	110	96,5	15,5	N 3/8	30	5,25	4,5	34	9	10	0,695	GE3NNT24011AF10	GE3NNT24044AF10
GE3 N 1/2	50 MPa	13	43	18	83	48,4	11	57	37	58,5	110	99,5	17	N 1/2	32	5,25	5	36	9	13	0,825	GE3NNT33011AF10	GE3NNT33044AF10
GE3 N 3/4	42/40 MPa	20	57	23,4	95	62,5	14	73,5	49	75	180	106,5	21	N 3/4	41	6,25	6	50	14	20	1,583	GE3NNT44011AF10	GE3NNT43044AF10
GE3 N 1	42/35 MPa	25	65	29,5	112	66,5	14	83,5	55	89	180	116,5	24	N 1	50	6,25	6	50	14	25	2,421	GE3NNT53011AF10	GE3NNT53044AF10
GE3 N 1 1/4 R	35 MPa	25	65	29,5	120	66,5	14	83,5	55	89	180	116,5	24	N 1 1/4	55	6,25	6	50	14	25	2,601	GE3NNR63011AF10	GE3NNR63044AF10
GE3 N 1 1/2 R	35 MPa	25	65	29,5	124	66,5	14	83,5	55	89	180	116,5	24	N 1 1/2	60	6,25	6	50	14	25	2,756	GE3NNR73011AF10	GE3NNR73044AF10

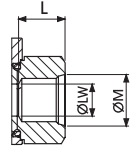

## GE3 SAE J1926-1

Fixing holes

CARBON STEEL

TYPE	PN	DN	A	B	C	D	E	F	G	H	I	L	ØM	CH	ØR	S	T	SW	ØLW	KG	ITEM CODE
GE3 SAE4	50 MPa	6	35	14,5	71	42,4	11	49	30	110	91,5	15,5	$\frac{7}{16}$ UNF	24	5,25	4,5	34	9	6	0,512	GE3EEE04011AF10
GE3 SAE6	50 MPa	10	40	17,5	73	44,8	11	54,25	35	110	96,5	16	$\frac{9}{16}$ UNF	30	5,25	4,5	34	9	10	0,695	GE3EEE14011AF10
GE3 SAE8	50 MPa	13	43	18	83	48,4	11	57	37	110	99,5	17,5	$\frac{3}{4}$ UNF	32	5,25	5	36	9	13	0,825	GE3EEE23011AF10
GE3 SAE12	42/40 MPa	20	57	23,4	95	62,5	14	73,5	49	180	106,5	23	$1\frac{1}{16}$ UNF	41	6,25	6	50	14	20	1,583	GE3EEE34011AF10
GE3 SAE16	42/35 MPa	25	65	29,4	112	66,5	14	83,5	55	180	116,5	23	$1\frac{5}{16}$ UNF	50	6,25	6	50	14	25	2,421	GE3EEE43011AF10
GE3 SAE20R	35 MPa	25	65	29,4	120	66,5	14	83,5	55	180	116,5	23	$1\frac{5}{8}$ UNF	55	6,25	6	50	14	25	2,601	GE3EEE53011AF10
GE3 SA24R	35 MPa	25	65	29,4	124	66,5	14	83,5	55	180	116,5	23	$1\frac{7}{8}$ UNF	60	6,25	6	50	14	25	2,756	GE3EEE63011AF10

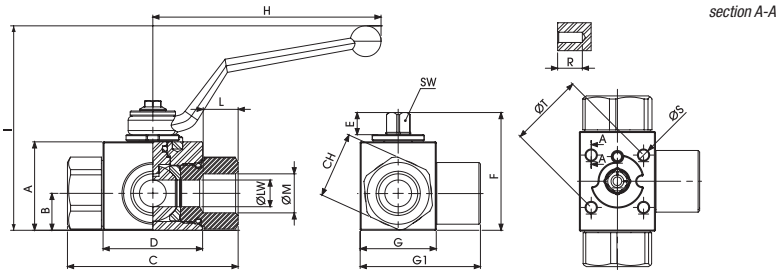

## GE3 DIN/ISO 228 BSP

Fixing holes DIN/ISO5211

CARBON STEEL STAINLESS STEEL

TYPE	PN	DN	A	B	C	D	E	F	G	G1	H	I	L	ØM	CH	R	ØS	ØT	ISO5211	SW	LW	KG	ITEM CODE	ITEM CODE
GE3 G $\frac{1}{8}$	50 MPa	4	35	14,5	71	42,4	11	49	30	48,5	110	91,5	11	G $\frac{1}{8}$	24	9,5	M4	35	F03	9	4	0,558	GE3GGT04011AF50	GE3GGT04044AF50
GE3 G $\frac{1}{4}$	50 MPa	6	35	14,5	71	42,4	11	49	30	48,5	110	91,5	15,5	G $\frac{1}{4}$	24	9,5	M4	35	F03	9	6	0,536	GE3GGT14011AF50	GE3GGT14044AF50
GE3 G $\frac{3}{8}$	50 MPa	10	40	17,4	73	44,4	11	54,25	35	54,5	110	96,5	15,5	G $\frac{3}{8}$	30	9,5	M5	36	F03	9	10	0,695	GE3GGT24011AF50	GE3GGT24044AF50
GE3 G $\frac{1}{2}$	50 MPa	13	43	18	83	48,4	11	57	37	58,5	110	99,5	17	G $\frac{1}{2}$	32	9,5	M5	36	F03	9	13	0,825	GE3GGT33011AF50	GE3GGT33044AF50
GE3 G $\frac{3}{4}$	42/40 MPa	20	57	23,4	95	62,5	14	73,5	49	75	180	106,5	21	G $\frac{3}{4}$	41	15	M6	50	F05	14	20	1,583	GE3GGT44011AF50	GE3GGT43044AF50
GE3 G 1	42/35 MPa	25	65	29,5	112	66,5	14	83,5	55	89	180	116,5	24	G 1	50	15	M6	50	F05	14	25	2,421	GE3GGT53011AF50	GE3GGT53044AF50
GE3 G 1 $\frac{1}{4}$ R	35 MPa	25	65	29,5	120	66,5	14	83,5	55	89	180	116,5	24	G 1 $\frac{1}{4}$	55	15	M6	50	F05	14	25	2,601	GE3GGR63011AF50	GE3GGR63044AF50
GE3 G 1 $\frac{1}{2}$ R	35 MPa	25	65	29,5	124	66,5	14	83,5	55	89	180	116,5	24	G 1 $\frac{1}{2}$	60	15	M6	50	F05	14	25	2,756	GE3GGR73011AF50	GE3GGR73044AF50

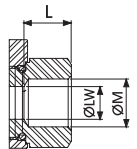

## GE3 ANSI/ASME B1.20.1 NPT

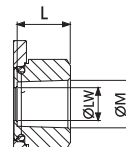

Fixing holes DIN/ISO5211

TYPE	PN	DN	A	B	C	D	E	F	G	G1	H	I	L	ØM	CH	R	ØS	ØT	ISO5211	SW	LW	KG	CARBON STEEL	STAINLESS STEEL
																							ITEM CODE	ITEM CODE
GE3 N 1/8	50 MPa	4	35	14,5	71	42,4	11	49	30	48,5	110	91,5	11	N 1/8	24	9	M4	35	F03	9	4	0,558	GE3NNT04011AF50	GE3NNT04044AF50
GE3 N 1/4	50 MPa	6	35	14,5	71	42,4	11	49	30	48,5	110	91,5	17	N 1/4	24	9	M4	35	F03	9	6	0,536	GE3NNT14011AF50	GE3NNT14044AF50
GE3 N 3/8	50 MPa	10	40	17,4	73	44,4	11	54,25	35	54,5	110	96,5	17	N 3/8	30	9	M5	36	F03	9	10	0,695	GE3NNT24011AF50	GE3NNT24044AF50
GE3 N 1/2	50 MPa	13	43	18	83	48,4	11	57	37	58,5	110	99,5	21	N 1/2	32	9	M5	36	F03	9	13	0,825	GE3NNT33011AF50	GE3NNT33044AF50
GE3 N 3/4	42/40 MPa	20	57	23,4	95	62,5	14	73,5	49	75	180	106,5	21	N 3/4	41	15	M6	50	F05	14	20	1,583	GE3NNT44011AF50	GE3NNT43044AF50
GE3 N 1	42/35 MPa	25	65	29,5	112	66,5	14	83,5	55	89	180	116,5	24	N 1	50	15	M6	50	F05	14	25	2,421	GE3NNT53011AF50	GE3NNT53044AF50
GE3 N 1 1/4 R	35 MPa	25	65	29,5	120	66,5	14	83,5	55	89	180	116,5	24	N 1 1/4	55	15	M6	50	F05	14	25	2,601	GE3NNR63011AF50	GE3NNR63044AF50
GE3 N 1 1/2 R	35 MPa	25	65	29,5	124	66,5	14	83,5	55	89	180	116,5	24	N 1 1/2	60	15	M6	50	F05	14	25	2,756	GE3NNR73011AF50	GE3NNR73044AF50

## GE3 SAE J1926-1

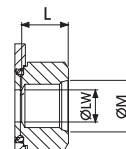

Fixing holes DIN/ISO5211

TYPE	PN	DN	A	B	C	D	E	F	G	H	I	L	ØM	CH	R	ØS	ØT	SW	ØLW	KG	CARBON STEEL
																					ITEM CODE
GE3 SAE4	50 MPa	6	35	14,5	71	42,4	11	49	30	110	91,5	15,5	7/16 UNF	24	9	M4	35	9	6	0,512	GE3EEE04011AF50
GE3 SAE6	50 MPa	10	40	17,5	73	44,8	11	54,25	35	110	96,5	16	9/16 UNF	30	9	M4	35	9	10	0,695	GE3EEE14011AF50
GE3 SAE8	50 MPa	13	43	18	83	48,4	11	57	37	110	99,5	17,5	3/4 UNF	32	9	M5	36	9	13	0,825	GE3EEE23011AF50
GE3 SAE12	42/40 MPa	20	57	23,4	95	62,5	14	73,5	49	180	106,5	23	1 1/16 UNF	41	9	M5	36	14	20	1,583	GE3EEE34011AF50
GE3 SAE16	42/35 MPa	25	65	29,4	112	66,5	14	83,5	55	180	116,5	23	1 5/16 UNF	50	15	M6	50	14	25	2,421	GE3EEE43011AF50
GE3 SAE20R	35 MPa	25	65	29,4	120	66,5	14	83,5	55	180	116,5	23	1 5/8 UNF	55	15	M6	50	14	25	2,601	GE3EEE53011AF50
GE3 SA24R	35 MPa	25	65	29,4	124	66,5	14	83,5	55	180	116,5	23	1 7/8 UNF	60	15	M6	50	14	25	2,756	GE3EEE63011AF50